

Chisel Cartridge 8 x 2.5

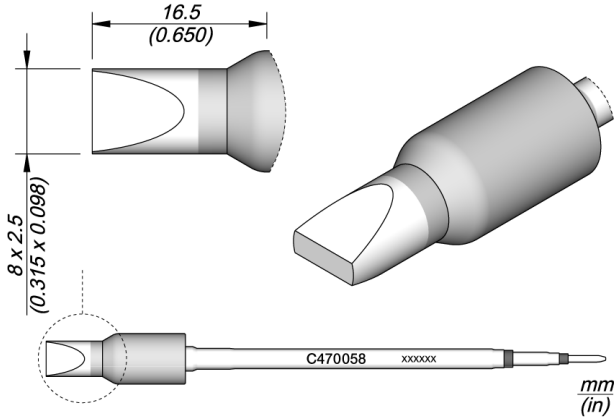

C470 cartridges are the largest ones of the JBC range.

This range features many shapes, sizes and special models.

Due to their size, these cartridges are appropriate for intensive soldering purposes and they are perfect for both SMD and applications with high power requirements.

They work with T470 Handpieces.

JBC Long Life Tips offer instant heat up, excellent heat transfer and great durability.

They last 5 times longer than other brands thanks to the JBC Most Efficient Soldering System and the Sleep & Hibernation features.

REFERENCE

C470058

SPECIFICATIONS

Net weight 0,03 kg (0.06lb)

WEIGHT AND DIMENSIONS

26 gr (0.06 lb)

36 gr (0.08 lb)

122 x 60 x 34 mm

Copyright © 2023 JBC Soldering S.L. | [Legal Notice](#) | [Privacy Policy](#) | [Terms and Conditions](#) | [Cookie policy](#) | [RSS Feed](#) | [JBC Store](#) | [Contact Us](#)

CONNECTABLES

Compatible tools



T470-A

Heavy Duty Handle



T470-SA

Heavy Duty Handle with 3m cable



T470-ZA

Tri-lobed Grip HD Handle for better handling



T470-FA

Thermal Insulator Grip Heavy Duty Handle