

Bevel Cartridge Ø 2.8

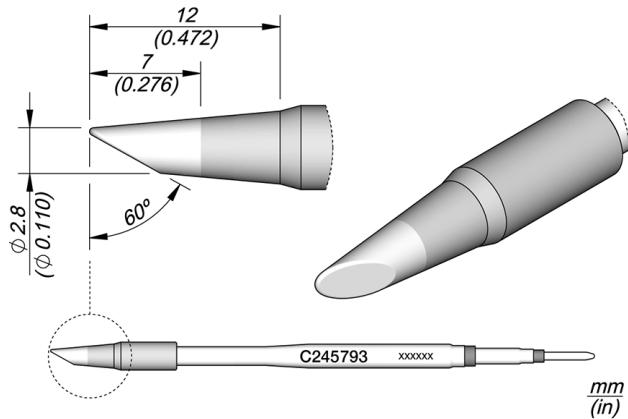

This cartridge has a reduced tinned surface ideal for touching up.

C245 cartridge range is the widest one of JBC with many shapes, sizes and special models.

They are appropriate for general soldering purposes and they are perfect for both SMD components or for applications with high power requirements such as ground plane soldering.

They work with T245 Handpieces.

JBC Long Life Tips offer instant heat up, excellent heat transfer and great durability.

They last **5 times longer** than other brands thanks to the JBC Most Efficient Soldering System and the Sleep & Hibernation features.

REFERENCE

C245793

SPECIFICATIONS

Net weight 0,005 kg (0.01lb)

WEIGHT AND DIMENSIONS

5 gr (0.01 lb)

20 gr (0.04 lb)

110 x 12 x 12 mm

CONNECTABLES

Compatible tools



T245-A

General Purpose Handle



T245-PA

Blue Grip General Purpose Handle



T245-NA

Nitrogen General Purpose Handle